



Installation Guideline

AZ[®]-800 | AZ[®]-750



Installation Guideline

AZ[®]-800 & AZ[®]-750

After the successful market introduction of the AZ[®]-700 sheet pile range and 10 years of proven track record, ArcelorMittal has taken a further step in the development of wider Z-piles. As a result, the AZ[®]-800 range has been presented to the market in 2015. Intensive testing before market introduction showed that installation can be performed with standard pile driving equipment. However, the optimum choice of a sheet pile section requires a more rigorous analysis of the soil conditions. Nowadays, the existing ArcelorMittal sheet pile range allows designers and contractors to choose amongst a variety of profiles to best cater for the particular site conditions. Soil characteristics and driving methods are closely linked and have to be considered carefully. This document provides guidance to users towards selecting the profile for best execution results.

In case of further questions, please contact our Technical Department, your local ArcelorMittal office and check our online library:

sheetpiling.arcelormittal.com



Geometry of the sheet pile sections

AZ[®]-800

AZ 18-800

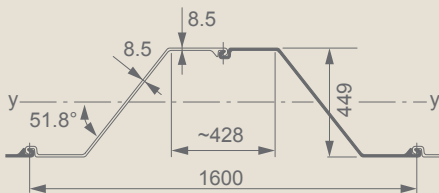

AZ 20-800

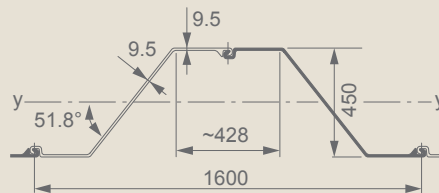

AZ 22-800

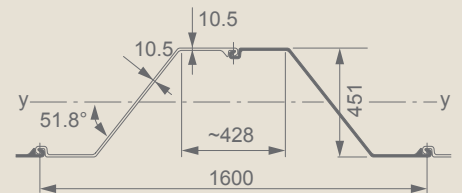

AZ 23-800

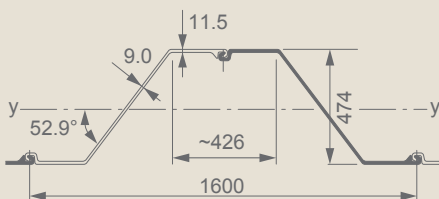

AZ 25-800

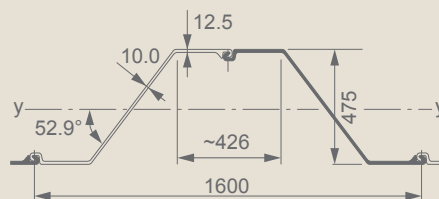

AZ 27-800

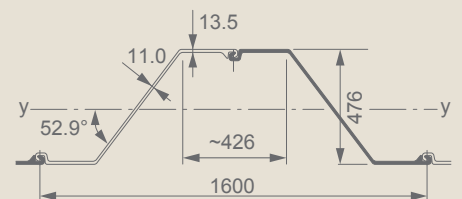

AZ[®]-750

AZ 28-750

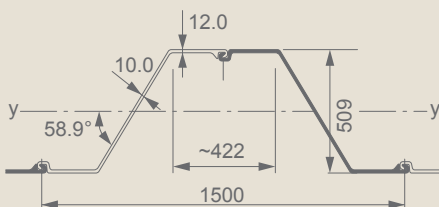

AZ 30-750

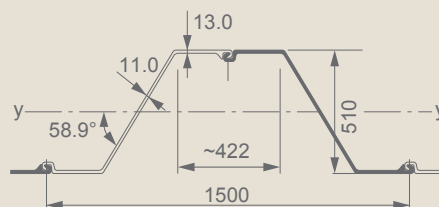

AZ 32-750

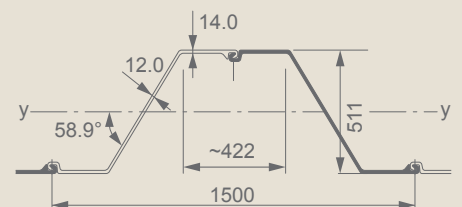

Special features of the sheet pile sections

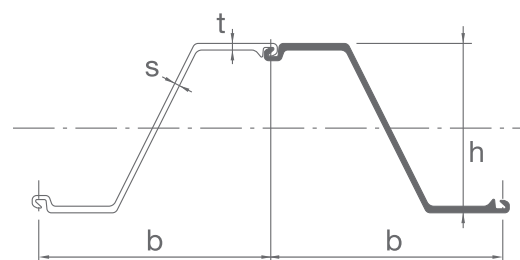

Section properties

Section	Width Height		Thickness		Sectional area cm ² /m	Mass		Moment of inertia cm ⁴ /m	Elastic section modulus cm ³ /m	Static moment cm ³ /m	Plastic section modulus cm ³ /m	Class ¹⁾							
	b mm	h mm	t mm	s mm		single pile kg/m	wall kg/m ²					S 240 GP	S 270 GP	S 320 GP	S 355 GP	S 390 GP	S 430 GP	S 460 AP	
AZ°-800																			
AZ 18-800	800	449	8.5	8.5	129	80.7	100.9	41 320	1 840	1 065	2 135	3	3	3	3	3	4	4	
AZ 20-800	800	450	9.5	9.5	141	88.6	110.7	45 050	2 000	1 165	2 330	3	3	3	3	3	3	3	
AZ 22-800	800	451	10.5	10.5	153	96.4	120.5	48 790	2 165	1 260	2 525	2	2	3	3	3	3	3	
AZ 23-800	800	474	11.5	9.0	151	94.6	118.2	55 260	2 330	1 340	2 680	2	2	2	3	3	3	3	
AZ 25-800	800	475	12.5	10.0	163	102.6	128.2	59 410	2 500	1 445	2 890	2	2	2	2	2	3	3	
AZ 27-800	800	476	13.5	11.0	176	110.5	138.1	63 570	2 670	1 550	3 100	2	2	2	2	2	2	2	
AZ°-750																			
AZ 28-750	750	509	12.0	10.0	171	100.8	134.4	71 540	2 810	1 620	3 245	2	2	2	2	3	3	3	
AZ 30-750	750	510	13.0	11.0	185	108.8	145.0	76 670	3 005	1 740	3 485	2	2	2	2	2	2	3	
AZ 32-750	750	511	14.0	12.0	198	116.7	155.6	81 800	3 200	1 860	3 720	2	2	2	2	2	2	2	

¹⁾ Classification according to EN 1993-5. Class 1 is obtained by verification of the rotation capacity for a class-2 cross-section. A set of tables with all the data required for design in accordance with EN 1993-5 is available from our Technical Department. Steel grade S 460 AP following specifications of the mill is available on request.

- > 31 m rolling length possible, longer piles on request
- > Delivery possible in exclusive ArcelorMittal steel grades S 460 AP and AMLoCor
- > High quality crimping of double piles for special applications
- > Excellent weldability because of low carbon equivalent value
- > Proven interlocking system with enhanced water tightness

Choice of section

Once the static calculation is done and section modulus, pile length as well as steel grade are defined, it has to be checked, whether length of pile and section modulus are adequate for installation in the given soil conditions

A well prepared geotechnical investigation should always be the basis for design and pile driving evaluation.

The following graph shall provide guidance for pile selection with respect to driving conditions.

Drivability of sheet piles in regard to length, soil conditions, section modulus and delivery form (pairs) for standard sheet pile walls is shown in the graph adapted from chapter eleven of the ArcelorMittal Piling Handbook, 9th edition, where further details and recommendations can be found.

As general rule of thumb it can be assumed that: "the recommended sheet pile length in [cm] corresponds to the section modulus in [cm³/m]". However, soil conditions have to be checked carefully.

Example: AZ 18-800

- > 1840 cm³/m section modulus;
- > Recommended length max. 15-18 m for soil condition "Easy".

Please note: this rule of thumb does not apply to combined walls, but is given only for standard sheet pile walls.

For HZ[®]-M type or other combined walls, installation has to be checked rather in regards to existing soil conditions and required length of piles.

The wider piles will have less plugging effect at the pile toe in certain soil conditions, but more surface friction has to be expected. Changing from an AZ 26-700 to an AZ 25-800 will increase the surface area by roughly 9%. This should be considered when choosing the driving equipment.

Installation aids, like water jetting or pre-drilling, can be foreseen, depending on prevailing soil conditions.

Water jetting is most effective in non-cohesive soils, while pre-drilling should be considered rather for cohesive soils. Both methods will facilitate installation, reduce necessary piling energy and minimize the effect of vibrations along adjacent buildings.

Soil definitions				
	SPT value (blows)		CPT value (in MN/m ²)	
	Cohesive	Non-cohesive	Cohesive	Non-cohesive
Easy	0 - 5	0 - 20	0 - 0.5	0 - 7.5
Normal	5 - 15	20 - 40	0.5 - 1	7.5 - 15
Hard	> 15	> 40	> 1	> 15

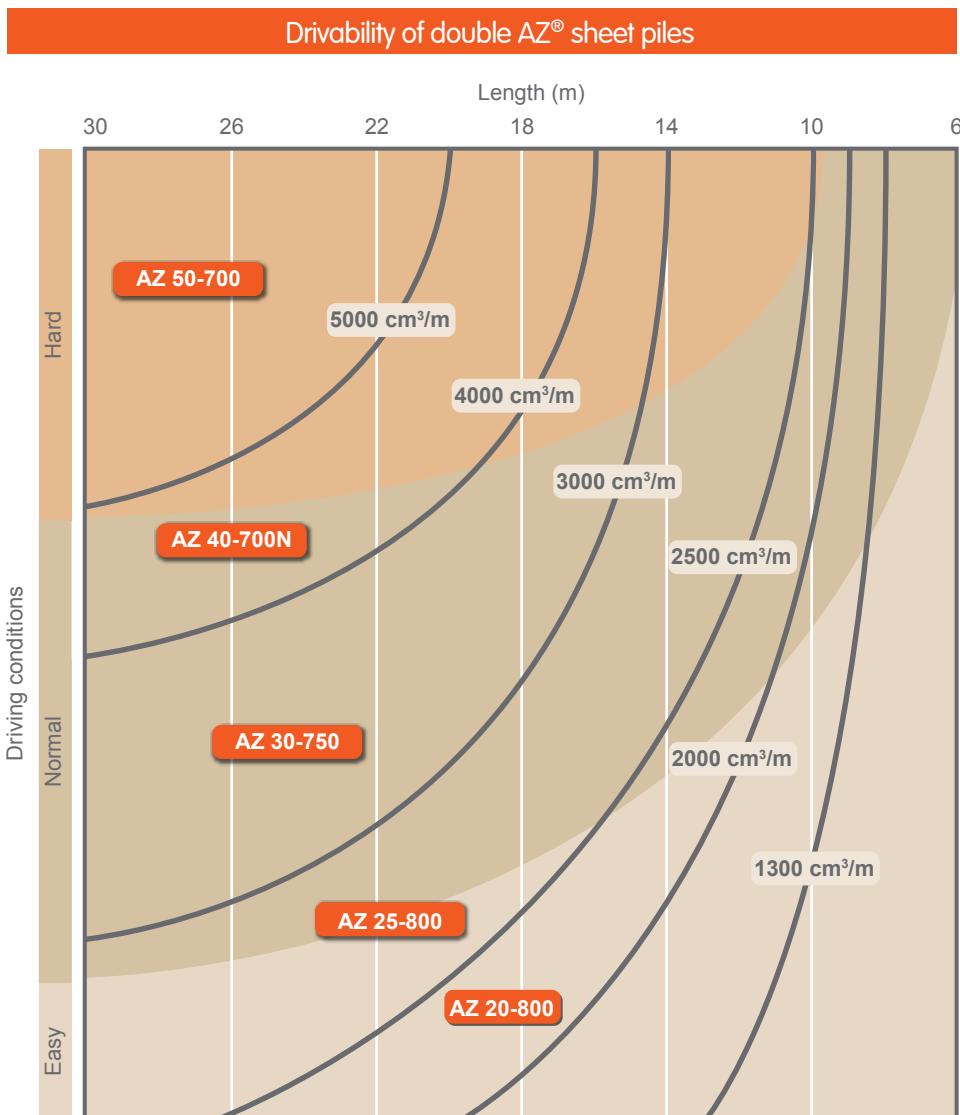

Installation methods

Vibrator and impact hammer

Installation of the AZ[®]-800 & AZ[®]-750 piles is possible with all standard installation methods:

- > vibrating
- > impact hammering
- > pressing

Installation with vibratory hammer

The dimensioning of piling equipment is generally driven by equipment availability and contractor's experience. Calculation formulae or curves and tables can be found in the ArcelorMittal Piling Handbook or in the recommendations of the machine manufacturers.

The connection between pile and vibratory hammer is the clamping device. The clamping force shall be more than 1.2-times the flyforce (in kN) of the vibratory hammer. The surface of the clamps shall be large enough and not worn-off to prevent damage to the pile head.

Installation is still often done with a single-clamp setup, gripping the pile over the middle interlock.



Leader-mounted vibratory hammer with double clamps



Single clamp

This method introduces forces out of the center of gravity of the wall and causes bending in the pile head, as well as additional friction in the adjacent interlocks. The use of single clamps is acceptable, but the preferred option should always be a double clamping system, to avoid damage to piles and driving equipment.

For piles with a width of 700 mm and larger, ArcelorMittal recommends the use of double clamps for double-Z piles, as the energy loss due to flapping ends can cause slower installation progress.

The benefit of using double clamps is especially given when installing AZ-800 double piles.

In addition, it is recommended to have the piles crimped or welded to avoid differential movements of the double pile under the clamps.

Turning plates for the different web angles are available from all major piling equipment manufacturers. In case of need, ArcelorMittal can provide contact details.

Dimensioning of driving forces can be done according to the existing methods, but close attention has to be paid to the soil conditions.

In soil conditions that are prone to plugging, stiffening plates or strips can be affixed slightly recessed from the pile tip. This is beneficial as the effects on pile driving caused by the soil plug is reduced. Hence, aiding in achieving installation tolerances (e.g. wall length, inclination, design depth).

Installation with impact hammer

Today's standard machines are either hydraulic or diesel hammers; steam hammers are no longer in use. Fast-acting air-driven hammers are available and can be used for all pile sizes.

It is essential to use a correctly sized driving cap. The cap shall cover all of the pile area, leaving free the outside interlocks. The driving of double piles is to be preferred. The driving cap must be sufficiently rigid to transfer safely the impact energy from the hammer into the pile. Driving caps can be custom-made by the contractor, requested from the hammer manufacturer or can be obtained from ArcelorMittal on request for the use with diesel or free-fall hammers. Care shall be taken not to overstress the pile or the cap during driving.

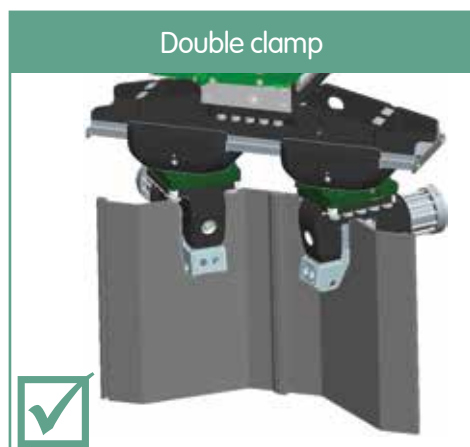

Double clamp

Installation methods

Driving caps

Sheet pile sections and corresponding driving caps

Arrangement	D ¹⁾	D ¹⁾
Driving caps	ZD 800 A	ZD 800 B

AZ[°]-800 sections

AZ 18-800	✓	
AZ 20-800	✓	
AZ 22-800	✓	
AZ 23-800	✓	✓
AZ 25-800	✓	✓
AZ 27-800	✓	✓

AZ[°]-750 sections

AZ 28-750		✓
AZ 30-750		✓
AZ 32-750		✓

¹⁾ D = Double pile.

²⁾ Availability to be checked at time of order placement.

Sliding guides

Sliding guides are designed to guide the driving cap along the leader, thus guaranteeing proper alignment of the hammer in the centre of the driving cap. The adaptation to the leader is normally carried out on-site.

Dimensions

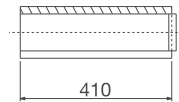
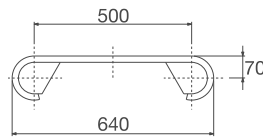

Designation

500/90

Corresponding driving caps

ZD 800 A-weld
ZD 800 B-weld

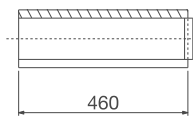
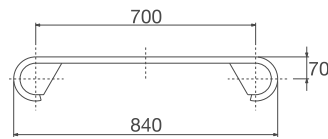

700/90

ZD 800 A
ZD 800 B²⁾

Arrangement of driving caps

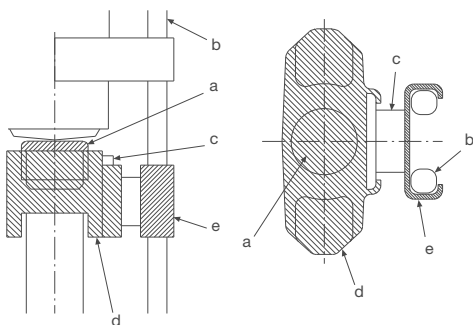

a = dolly/cushion

b = leader

c = sliding guide

d = driving cap

e = leader slide

The leader slide (e) is not provided by ArcelorMittal.



Driving cap for impact hammer

Installation methods

Pressing

Installation by pressing

Especially in inner-city areas, pressing has become a standard vibration-free installation technology. Two types of presses are available on the market:

- > self-walking presses;
- > leader guided systems.

The width limitation of the self-walking systems today is at 1.40 m, length limitation of the section depends on the soil conditions, but is normally between 15-19 m. Pre-drilling and water-jetting are possible to improve the working progress.

Leader guided presses do exist for the AZ-800/AZ-750 profile series. The availability of equipment has to be checked with the specific manufacturers. It should be considered that more surface friction has to be overcome with the wider piles and that the pressing machine must have sufficient rigidity and power reserves to press the piles in the ground safely.

Pressing and vibrating can be facilitated by filling the interlock with lubricants, such as Beltan®Plus, grease or foam. A bolt at the end of the leading interlock in driving direction also prevents soil from entering the interlocks, as densified soil inside the interlocks may cause additional resistance while driving.



Self-walking press



Leader guided pressing system



Closing interlocks with foam or grease



Bolt inserted in leading interlock

Soil conditions

A well prepared soil investigation is key to a successful project

SPT/CPT tests, together with additional core drilling in the axis of the future structure, should be done to allow for the best possible evaluation of the intended working methods in regard to existing soil conditions.

In general, pile driving is possible in all kinds of soil, even in weathered rock, provided the piling method and pile section are chosen correctly.

Non-cohesive soils are best suited for vibrating. If SPT values > 50 blows prevail, additional water-jetting should be considered. If there is a high content of fine particles (< 0.1 mm), filling of the leading interlocks with foam, Beltan®Plus or grease is strongly recommended.

In situations with SPT values > 45 blows, a strong Z-pile with minimum elastic section modulus W_{el} of 2500 cm³/m should be selected. Length recommendation as mentioned on page 4 shall be verified.

General rule of thumb: "the harder the soil, the stronger and stiffer the sheet pile section should be".

Cohesive soils are best suited for impact pile driving; if vibration is used, a high amplitude is demanded. If CPT values > 1.0 MPa prevail, additional pre-drilling and strengthening of the pile toe with plates or rock shoes can be considered. Soft cohesive soils are suitable for pressing.

In situations with CPT values > 1.0 MPa, a strong Z-pile with minimum W_{el} of 2500 cm³/m should be used. Length recommendation as mentioned on page 4 should be verified. In general, installation of AZ® single piles is not recommended.

Installation in **soft or weathered rock** (< 5 MPa compression strength) is possible with high capacity impact hammers and sheet pile section modulus > 3600 cm³/m. Toe strengthening, pre-drilling or cutting with a trench cutter can be considered, depending on rock condition and driving depth.

Combined walls

Combined walls consist of high-inertia and massive primary elements, like HZ®-M beams, sheet pile box piles or tubes, with standard sheet piles as intermediary sheet piles in between

The new AZ 20-800, AZ 25-800, AZ 30-750 and their derivatives can be used as intermediary piles for combined walls.

The preferred choice of intermediary sheet pile is the AZ® double pile. Because of the location of the middle interlock, a natural rotation capacity is given.

The maximum theoretical swing α in every Larssen interlock is 5°, depending on the length of pile. The rotation is only geometrical, no additional tension is introduced into the section. A special crimping setup allows keeping the rotation capacity in the lower part of the sheet pile in case piles are ordered with crimping from the mill.

According to the standard delivery conditions based on EN 10248, the tolerance of a double pile is +/- 3% of the pile width:

	Width	Tolerance
AZ 18	1.26 m	+/- 3.8 cm
AZ 18-700	1.40 m	+/- 4.2 cm
AZ 18-800	1.60 m	+/- 4.8 cm



For a combined wall system this means that a difference of 7-10 cm can occur, with marginal material deformation.

System width example:
HZ 1080M A-12 / AZ 25-800

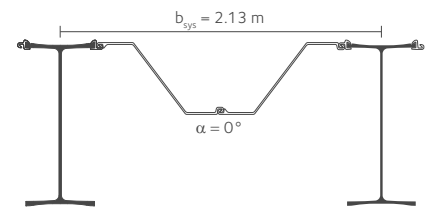

Theoretical system

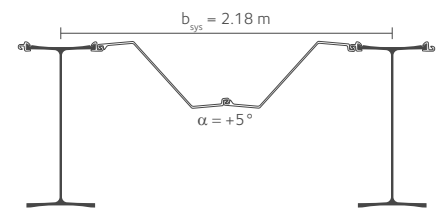

Wider system

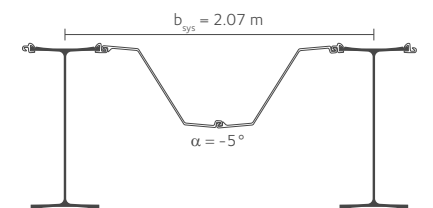

Narrower system

In hard soil conditions, toe strengthening can be taken into account. In addition pre-drilling or water jetting might be necessary to install the intermediary piles safely.

In general, the intermediary piles have 70-80 % of the length of the king piles; the exact length shall always be determined for each specific project.

For lifetime reasons, a minimum wall thickness of 10 mm in freshwater or seawater structures should be considered.

Technical assistance

ArcelorMittal has a technical department with vast design and installation experience available to assist with any queries that may arise.

A full suite of technical documentation, such as the ArcelorMittal Piling Handbook, HZ[®]-M brochure and calculation programs are available for download at the following address:

> sheetpiling.arcelormittal.com

In case of further questions or clarifications, please contact your local ArcelorMittal representative or our Technical Department at:

> sheetpiling@arcelormittal.com





AZ[®]-800 | AZ[®]-750

A success story
made in Europe

Project references

AZ[®]-800 & AZ[®]-750

Project location	Section	Application	Total tonnage	Productivity Piles/day	Page
Goole, GB	AZ 30-750	Flood protection	1300	20	12
Lauwersoog, NL	AZ 30-750	Quay wall	670	15	13
Biblis, DE	AZ 20-800	Flood protection	1500	20-30	14
Saint-Laurent-du-Var, FR	AZ 25-800	Flood protection	2590	n.a.	15
Bocholt, BE	AZ 20-800	Erosion protection	2740	25	16
Vlissingen, NL	AZ 23-800	Quay wall	400	8	17
Brussels, BE	AZ 27-800	Parking	450	n.a.	18
Oslo, NO	AZ 23-800	Railway tunnel	2900	16	19
Zeeland, NL	AZ 25-800	Pile test	10	n.a.	20
Hamburg, DE	AZ 25-800	Foundation	240	n.a.	21
Amsterdam, NL	AZ 18-800	Retaining wall	1200	8	22
Cape Town, ZA	AZ 25-800	Pile test	7	n.a.	23

Project references

AZ[®]-750



Chantry Cottages | Goole

Great Britain | 2015

Section

- > AZ 30-750, 11.0 m length, S 355 GP, approx. 1300 t

Type of structure

- > Flood protection

Equipment

- > PVE 38M vibratory hammer
- > Standard frequency, 1200 kN flyforce, 38 kgm eccentric moment
- > Single clamp

Soil conditions

- > Sand, clay, SPT 20-30 blows

Job details

- > Quick execution, 2-level driving guide
- > Choice of section for durability reasons

Project references

AZ[®]-750



Haven 22 | Lauwersoog

The Netherlands | 2016

Section

- > AZ 30-750, 20.0 m length, S 430 GP, approx. 670 t

Type of structure

- > Quay wall with shiplift

Equipment

- > PVE 2319VM vibratory hammer
- > High frequency, 1100 kN flyforce, 0-19 kgm eccentric moment
- > Single clamp DWK150T

Soil conditions

- > Silty sand, SPT 30-40 blows

Job details

- > Maximum 10 minutes driving time per double pile
- > Installation from land and water
- > 1-level guiding frame

Project references

AZ[®]-800

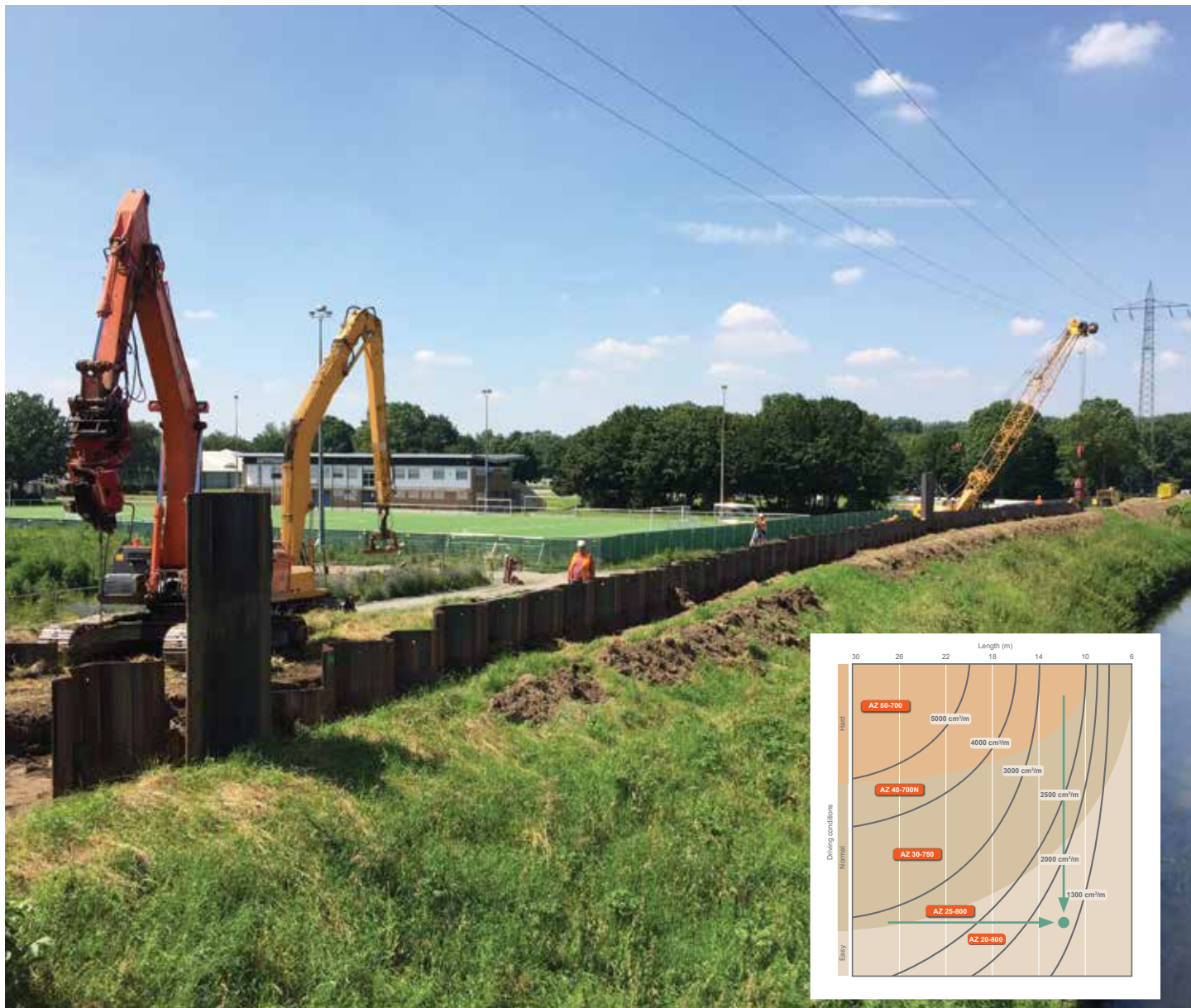

Weschnitzdeich | Biblis

Germany | 2016

> Example how to check pile driving in regard to length and soil conditions

Section

> AZ 20-800, 9.0-12.0 m length, S 240 GP, approx. 1500 t

Type of structure

> Flood protection

Equipment

> Müller MS 32HFV vibratory hammer
> High frequency, 1980 kN flyforce, 0-32 kgm eccentric moment
> Double clamp

Soil conditions

> Backfill (loose), sand, SPT 10-20 blows

Job details

> High installation performance: 20-30 double piles per day
> Interlocks filled with Beltan[®] Plus
> Use of Dixeran declutching detectors

Project references

AZ[®]-800



Flood protection | Saint-Laurent-du-Var

France | 2016

Section

- > AZ 20-800^{-0.5} / AZ 23-800 / AZ 25-800, 15.0 m length, S 355 GP, approx. 2590 t

Type of structure

- > Flood protection

Equipment

- > PTC 23HFV vibratory hammer
- > High frequency, 1360 kN flyforce, 0-23 kgm eccentric moment
- > Single and double clamp
- > Delmag D 19-52 diesel hammer with ArcelorMittal driving cap

Soil conditions

- > Backfill (compact), sand, SPT > 45 blows

Job details

- > Driving test to prove performance of new AZ-800 piles
- > Installation with vibratory hammer and diesel hammer
- > 2-level guiding frame
- > Successful installation of AZ 20-800 in very hard ground conditions

Project references

AZ[®]-800



Canal rehabilitation | Bocholt

Belgium | 2016

Section

- > AZ 20-800^{-0.5}, 6.0 m and 8.0 m length, S 355 GP, approx. 2740 t

Type of structure

- > Erosion protection

Equipment

- > ICE 8RFSH vibratory hammer
- > Normal frequency, 436 kN flyforce, 0-7.5 kgm eccentric moment
- > Single clamp, excavator-mounted with swivel head

Soil conditions

- > Sand (loose), clay (soft)

Job details

- > Cantilever wall for erosion protection along a canal
- > Installation with floating equipment
- > 1-level driving guide
- > Performance: up to 25 double piles per day

Project references

AZ[®]-800



Quarleshaven | Vlissingen

The Netherlands | 2016

Section

- > AZ 23-800, 23.0 m length, S 355 GP, approx. 400 t

Type of structure

- > Quay wall

Equipment

- > PVE 2350VM vibratory hammer
- > High frequency, 2900 kN flyforce, 0-50 kgm eccentric moment
- > Double clamp PPK175T

Soil conditions

- > Dense sand with stones, stiff clay, CPT > 30 MPa

Job details

- > Tube-combi-wall for new quay structure in very hard ground conditions
- > Installation of tubes with PVE110 and IHC S200 hydraulic hammer
- > 1-level driving guide
- > Performance: up to 8 AZ-800 double piles per day
- > Waterjetting or pre-drilling not permitted

Project references

AZ[®]-800



Parking „Spiegel / Mirroir“ | Brussels

Belgium | 2016

Section

- > AZ 27-800, 6.5 m–16.0 m length, S 355 GP, approx. 450 t

Type of structure

- > Permanent retaining wall for 3 level underground car park

Equipment

- > Piles placed in a CSM wall (Cutter Soil Mix) with PTC 30HFV

Soil conditions

- > Sandy silty clay

Job details

- > Anchoring not possible due to surrounding buildings
- > Top-down construction method used, where the basement floors act as strutting system
- > Installation in a soil-mix-wall to prevent vibrations damaging surrounding buildings and to achieve water tightness during excavation
- > Interlocks will be seal-welded after excavation

Project references

AZ[®]-800



Follobanen | Oslo

Norway | 2016

Section

- > AZ 23-800, up to 18.0 m length, S 430 GP, approx. 2900 t

Type of structure

- > Railway tunnel

Equipment

- > ICE 28RF, regular frequency machine with 1624 kN flyforce
- > RTG19 with MRV105 vibrator
- > Leader-guided pressing was used in sensitive areas

Soil conditions

- > Soft clays in the upper layers, (SPT 10-20 blows), granite bedrock in the lower strata

Job details

- > Sheet piles as permanent and temporary retaining structures for railway tunnel construction
- > Use of Beltan[®]Plus sealing system
- > Rockbolting as pile toe support
- > Pile splicing up to 54.0 m length
- > Productivity: up to 16 double piles per day

Project references

AZ[®]-800



Pile driving test | Zeeland

The Netherlands | 2016

Section

- > AZ 20-800 and AZ 25-800, 16.0 m length, S 430 GP

Type of structure

- > Pile test

Equipment

- > Resonator RD260 with single and double camp

Soil conditions

- > Clays and sand, medium dense soil

Job details

- > Successful pile driving test to verify the drivability of the AZ-800 sheet pile range with the new resonating pile driving method

Project references

AZ[®]-800



Foundation works steel mill | Hamburg

Germany | 2017

Section

- > AZ 25-800, up to 20.8 m length, S 240 GP, approx. 240 t

Type of structure

- > Retaining wall

Equipment

- > PTC 30HFV with 1641 kN flyforce and hydraulic drop hammer

Soil conditions

- > Sand, medium dense soil

Job details

- > AZ 25-800 used as intermediary sheet pile for a combined wall with HZ 880M A & B
- > Foundation of new electric arc furnace, installation close to existing structures

Project references

AZ[®]-800



Foundation | Amsterdam

The Netherlands | 2017

Section

- > AZ 18-800, AZ 25-800 up to 17.8 m length, S 240 GP, approx. 1200 t

Type of structure

- > Canal embankment and retaining wall

Equipment

- > Hydraulic 4 cylinder leader-guided pressing system

Soil conditions

- > Loose to medium dense sand, reclaimed

Job details

- > Tender demanded installation without vibration
- > Pressing is done in two steps with two machines to guarantee correct wall alignment
- > Average productivity: 8 double piles per day

Project references

AZ[®]-800



Pile driving test | Cape Town

South Africa | 2017

Section

- > AZ 25-800, 12.0 m length, S 430 GP

Type of structure

- > Pile test

Equipment

- > Vibratory hammer PTC 23HF3 with 1360 kN flyforce
- > Single clamp

Soil conditions

- > Fine sand, ferruginised sand, SPT 45 blows

Job details

- > Pile test to prove drivability of the new sections in subtropical soil conditions

Documentation

Please refer to our website to download all our documentation: sheetpiling.arcelormittal.com or contact us via E-mail: sheetpiling@arcelormittal.com



General catalogue
GB, DE, FR

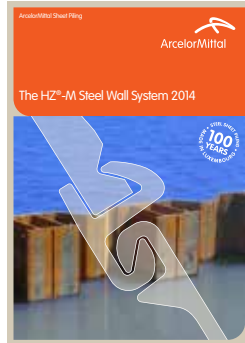

The HZ[®]-M Steel Wall System
GB, DE, FR, US, IT, SP, PT



AS 500[®] Straight web steel sheet piles. Design and execution.
GB

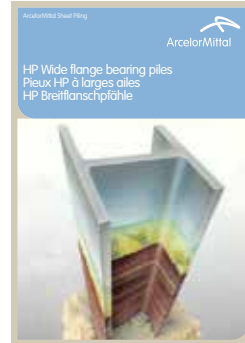

HP bearing piles
GB, DE, FR, SP

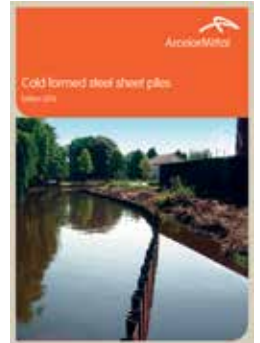

Cold formed steel sheet piles
GB, DE, FR, NL



Harbour construction
GB



Underground car parks
GB, PT

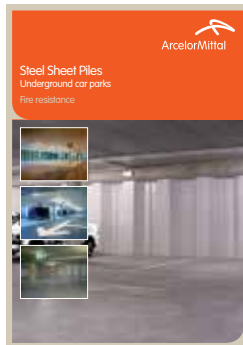

Underground car parks
Fire resistance
GB



High speed line south – NL
GB, FR, NL

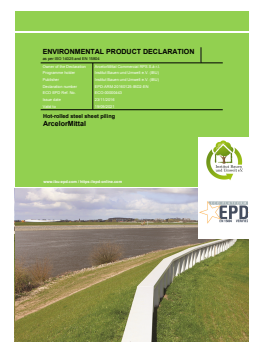

Environmental product declaration
GB



Installation of sheet piles
GB, DE, FR

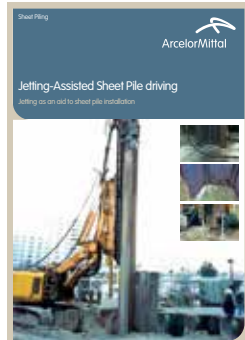

Jetting-assisted sheet pile driving
GB, DE, FR



Spirally welded steel pipes
GB



Off-centre anchoring
GB, DE, FR



Impervious steel sheet pile walls
GB, DE, FR



Piling Handbook
GB



Declutching detector
GB, DE, FR

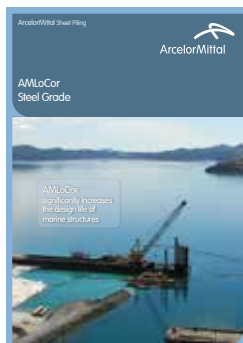

AMLoCor steel grade
AMLoCor 1A
GB, DE, RU



AZ sheet piles in combined walls
GB, DE, FR



Waste disposal
GB, DE, FR

Disclaimer

The data and commentary contained within this steel sheet piling document is for general information purposes only. It is provided without warranty of any kind. ArcelorMittal Commercial RPS S.à r.l. shall not be held responsible for any errors, omissions or misuse of any of the enclosed information and hereby disclaims any and all liability resulting from the ability or inability to use the information contained within. Anyone making use of this material does so at his/her own risk. In no event will ArcelorMittal Commercial RPS S.à r.l. be held liable for any damages including lost profits, lost savings or other incidental or consequential damages arising from use of or inability to use the information contained within. Our sheet pile range is liable to change without notice.

ArcelorMittal Commercial RPS S.à r.l.
Sheet Piling

66, rue de Luxembourg
L-4221 Esch-sur-Alzette (Luxembourg)

E sheetpiling@arcelormittal.com
sheetpiling.arcelormittal.com



Hotline: (+352) 5313 3105



[ArcelorMittalSP](#)



[ArcelorMittal Sheet Piling \(group\)](#)